

GODIAG PIRT Power Probe

**Apply to automobile power supply trouble shooting, fuel
injector nozzle cleaning and testing and relay testing
Instructions**

11.2021

1. Statement

Please carefully read the following statement:

GODIAG PIRT Power Probe Instruction helps you quickly understand how to use GODIAG PIRT Power Probe.

Please do not use it for illegal purposes, please abide by national laws.

The Instructions of GODIAG PIRT Power Probe is written by GODIAG company. No company or individual is allowed to copy this manual in any form (electronic official seal, mechanical, photocopy, recording, picture or any other forms). It can not be used for commercial purposes either.

2. Trademark Copyright

The brand 'GODIAG' has been registered in China and several overseas countries.

Disclaimer and Limitation of Liability All the information, specifications and illustrations in this manual are the latest information before the deadline of publication. The brand GODIAG reserves the right to change it without notice. The content in the manual has been carefully reviewed, but its accuracy and integrity are not guaranteed (including product specifications, functions, images).

Note: before operating or maintaining the equipment, please read this manual carefully, especially the safety precautions.

3. Technical Service Support

www.godiag.com

+86 18813687743

Sales@godiag.com

4. Safety Precautions

For the safety of yourself and others, and to avoid any damage to the equipment and vehicles, please read the safety precautions carefully. There are various procedures, tools, components and technologies used when maintaining vehicles. The operation methods of the them are different. Moreover, there are also lots of precautions for the vehicles when the vehicle maintenance is carried out. Therefore, this manual cannot predict every situation and provide safety recommendations for it accordingly.

It is the responsibility of automobile maintenance technicians to fully understand the test system and reasonably use appropriate maintenance methods and test procedures.

When testing, you must use appropriate operating methods to avoid threats to the personal safety of yourself and other people in the work area, and to avoid damage to the equipment being used or the vehicle being tested.

Before using the equipment, please refer to and follow the safety precautions and applicable test procedures provided by the vehicle or equipment manufacturer. When using the equipment please follow the instructions provided in this manual. Please carefully read, fully understand and strictly follow all safety information and instructions provided in the manual.

The basic safety precautions that should be followed when working on the vehicle:

- ◆ Please make sure that you are working in a safe environment. The automobile exhaust is harmful to human health, so please make sure that your workplace has adequate ventilation.
- ◆ Wear goggles that comply with ANSI standards.
- ◆ Adjust the gear to P (automatic) or N (manual), and make sure that the parking brake is activated (pull the handbrake).
- ◆ Keep the clothing, hair, hands, tools and equipment away from running engine parts or hot engine parts.
- ◆ Place bricks in front of all wheels to prevent accidental movement of the vehicle.
- ◆ During the testing and work, someone must watch over the vehicle.
- ◆ Be extremely careful when working near the ignition coil, distributor cap, ignition wire, and spark plug, because these components can generate dangerous voltages.
- ◆ Make sure there are fire extinguishers to put out fire caused by gasoline/chemical/electrical materials nearby.
- ◆ Do not plug or unplug the device when the ignition is turned on or the engine is working.
- ◆ Keep the equipment dry and clean, and avoid contact with oil, water or grease. Please use a clean cloth to wipe the equipment.
- ◆ Do not operate the diagnostic equipment while driving the vehicle to avoid car accidents caused by distractions.
- ◆ When the vehicles are serviced, please refer to the instructions in the maintenance manual, and operate in strict accordance with the requirements of the precautions. Otherwise, it may cause personal injury or damage to the diagnostic equipment.
- ◆ Do not place the diagnostic equipment on the distributor of the vehicle. Strong electromagnetic interference may cause damage to the equipment.

5. Content

1. Document Statement	Page 3
2. Trademark Copyright.....	Page 3
3. Technical Service Support	Page 3
4. Safety Precautions.....	Page 4
5. Content.....	Page 5
6. Product Overview.....	Page 6
7. Product Structure Introduction.....	Page 7
8. Product Parameters.....	Page 8
9. Power Supply.....	Page 8
10. Self-Test Before Use.....	Page 8
11. Product Function and Application Method.....	Page 10
12. Product Size.....	Page 27
13. Warranty Service.....	Page 28

6. Product Overview

GODIAG PIRT Power Probe is a specialized circuit maintenance testing tool developed for car maintenance workers and engineers. It can be used for the test of open circuit, short circuit and the voltage of the power supply line as well as the output of the positive and negative anodes. It is a high-level tool for judging positive and negative anodes. Its function also covers fuse testing, battery voltage testing, circuit voltage testing, relay testing, real and virtual electricity testing, ignition pulse signal testing, throttle voltage signal testing, vehicle LAN circuit testing, the Hall sensor performance testing, crankshaft induction testing, camshaft induction testing. What's more, GODIAG PIRT Power Probe can be used for fuel injector testing and has the function of automatically cleaning the fuel injector.

GODIAG PIRT Power Probe with reverse connection protection circuit is used for DC 6-40v cars, motorcycles, trucks, buses, engineering vehicles, ships, tractors, special mine vehicles, and other vehicles using DC circuits.

7. Product Structure Introduction

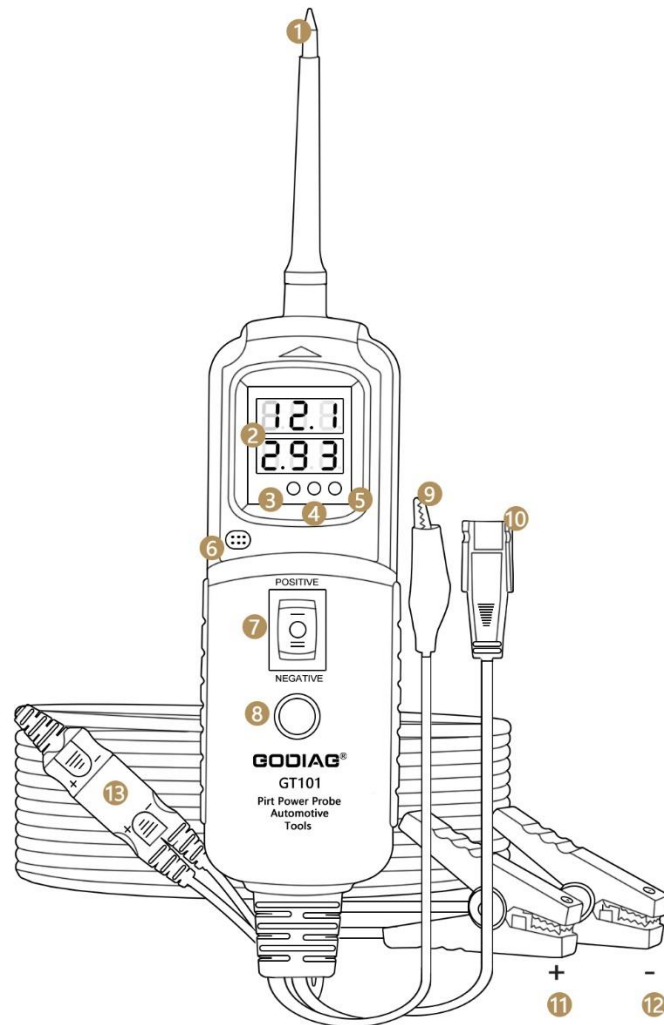

- ① Probe
- ② Current and voltage display screen
- ③ Pulse signal bi-color LED light (The green is to indicate the function output of the fuel injector and relay, the red is to indicate the pulse signal)
- ④ Battery negative indicator (0v/GND 0v/GND negative indicator)
- ⑤ Battery positive indicator (higher than 1v indicator)
- ⑥ Port of the Buzzer
- ⑦ Output switch (press the first position for the battery positive output, press the second position for battery negative output)
- ⑧ fuel injection nozzle relay function switch
- ⑨ Auxiliary ground wire
- ⑩ The test connection port of fuel injector, relay
- ⑪ Clip to connect positive electrode of the battery
- ⑫ Clip to connect negative electrode of the battery
- ⑬ Test lead extension port

8. Product Parameters

Items	Description
DC Power	DC Car battery power (6-40v Suitable for 6-40v)
Power Consumption	0.5 W
Operating Temperature	-5 to 50 degrees Celsius
Storage Temperature	-5 to 60 degrees Celsius
The Box Size:	25*18.7*8.5CM
The Main Unit Size:	18*5*2.7CM
Weight	1.2KG
Wire Length	620CM
Shell Material	ABS Environment-Friendly Materials

9. Power Supply

This product is powered by the vehicle battery. Please connect the black battery clip to the negative terminal of the vehicle battery, and the red battery clip to the positive terminal of the vehicle battery. When the tool is connected to the battery (power supply), the volt-ammeter will be on and the lighting LED will be on too.

10. Self-Test Before Use

Before testing the circuit or auto parts, please make sure that the tool is good and passes the self-test.

Self-Test Steps :

1. Connect the device to the car battery. (as shown in the figure 1)
2. Connect the probe pin to the positive electrode of the battery, and the red LED light should be on. The buzzer makes a rapid sound, and the voltmeter displays the current positive voltage. (as shown in the figure 2)
3. Connect the probe pin to the negative terminal of the battery, and the green LED light should be on. The buzzer makes a low-frequency sound, and the voltmeter displays a voltage of 0.00V. (as shown in the figure 3)
4. Activate the output function switch. When you press the power switch forward, the probe will output positive battery power. The red LED light should be on. The buzzer makes a rapid sound, and the voltmeter displays the current positive voltage. Release the switch, and the red LED light should be off and the sound disappears. The probe's positive output vanishes. (as shown in the figure 4)
5. Activate the output function switch, when you press the power switch backward, the

probe will output negative battery power. The green LED light should be on. The buzzer makes a low-frequency sound, and the voltmeter displays a voltage of 0.00V. Release the switch, and the green LED should be off and the sound disappears. The probe's positive output vanishes.

After the above self-test, if your tool can work normally, then you can use it without worry.

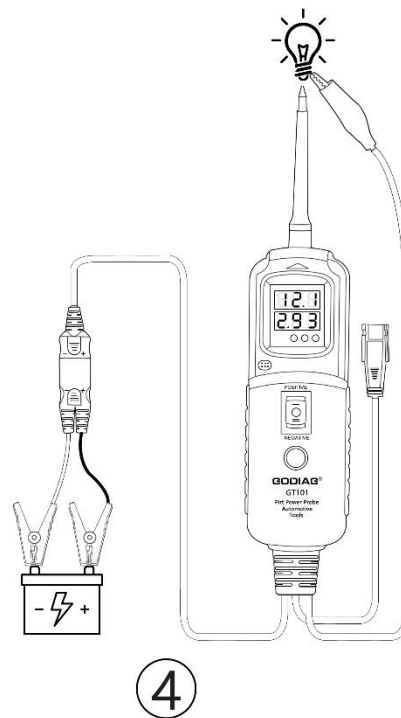
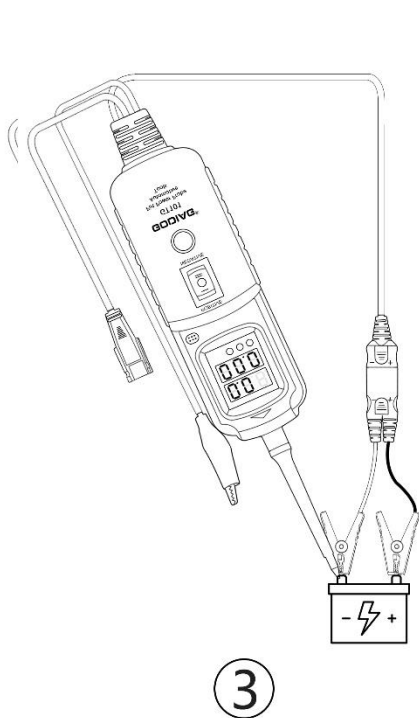
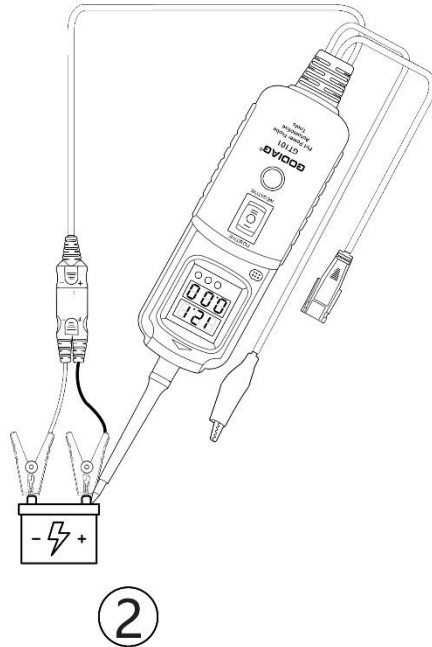
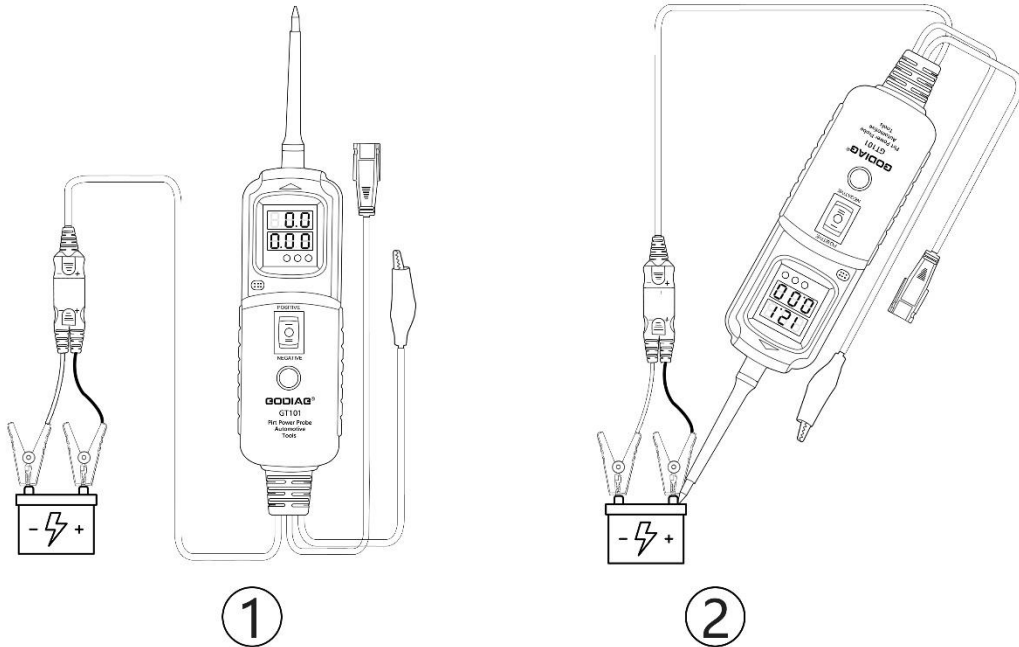

11. Product Function and Application Method

The working voltage of this product is DC 6V-40V, and the detection voltage is 0-80V.

The working current of this product is 200mA, and the ampere meter can measure the current range between 0-9A.

This product outputs 10A positive and negative current(single and double modules) to be on the safe side. Automatic protection trip current is 20A.

1.) Wiring detection voltmeter function---check whether the current wiring meets the design requirement of the vehicle circuit. The inspector needs to inspect it according to the circuit design schematic diagram.

Note: Please do not touch any buttons or switches when detecting the wiring. Avoid outputting positive and negative electricity to burn out circuits or accessories.

- A. Positive voltage detection: detect the current voltage of probe's touch point. Signal detection: when a pulse signal is detected in a circuit, the positive electricity indicator is on and the buzzer makes sounds. The red signal indicator is on, and the voltmeter displays the current voltage that it detects.
- B. Positive circuit detection: when the probe detects that the current circuit has a positive voltage (0.6v-40v), then the current circuit voltage value can be displayed. At this time the power indicator flashes quickly and the device makes a rapid sound.

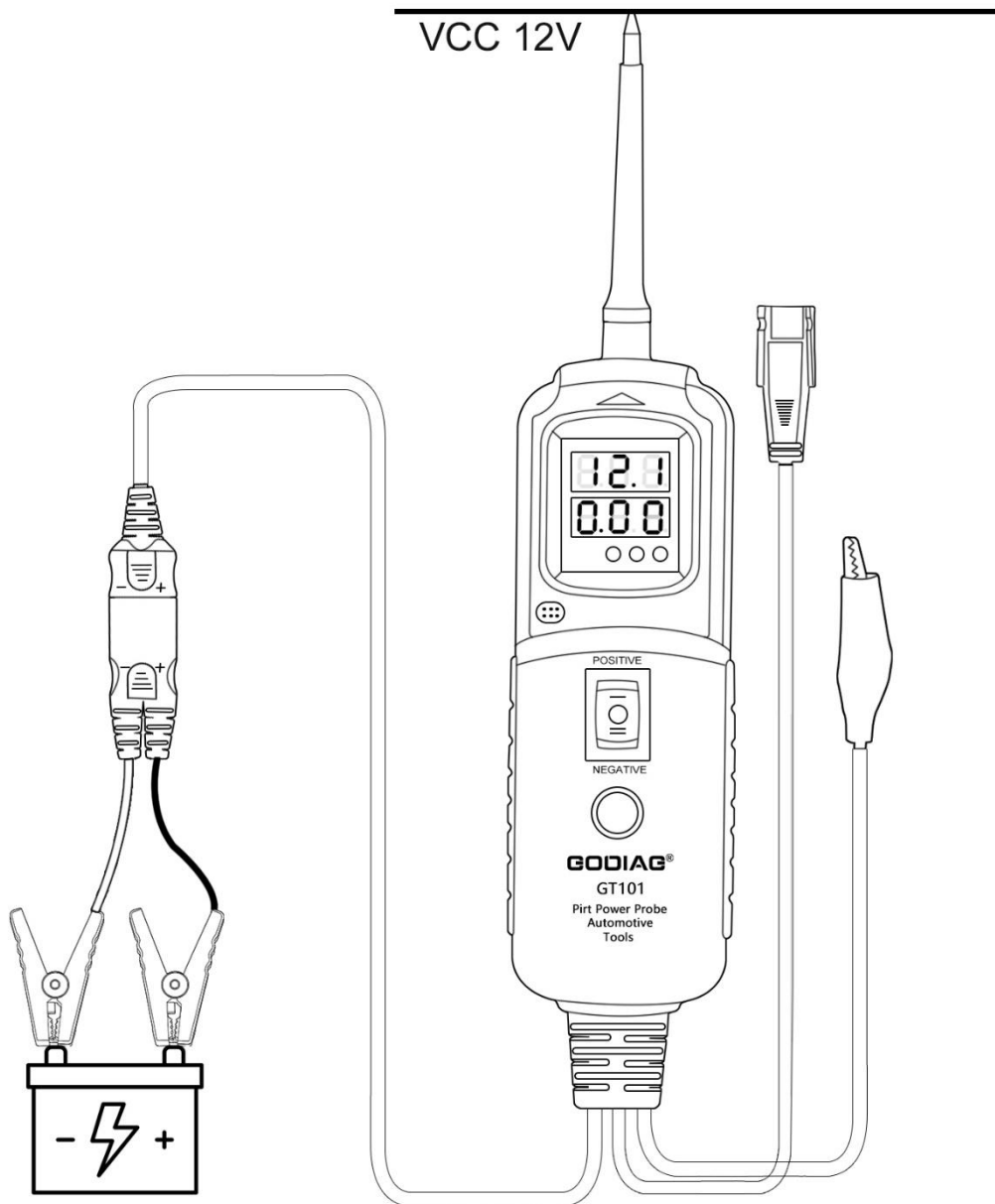

- C. GND/battery negative or ground detection: When the probe detects that the current circuit is battery negative or ground GND, the device will emit a low-frequency sound, the corresponding GND indicator will flash; and the voltmeter will display 0V.

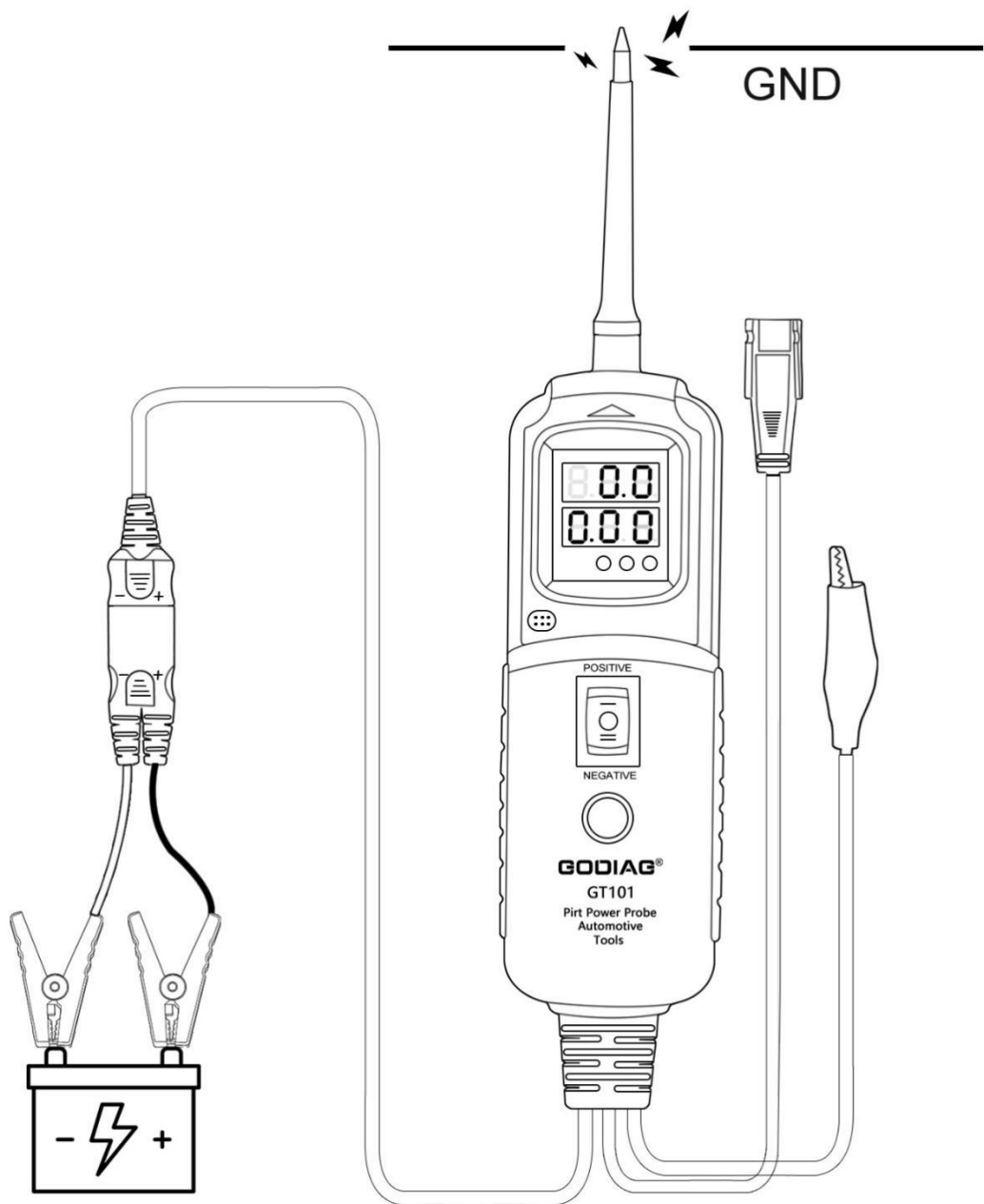

- D. Pulse signal communication signal detection: When a pulse signal with voltage is detected, the blue and the red light flash, and the buzzer emits a rapid sound. The voltmeter will display the voltage value of the current circuit.

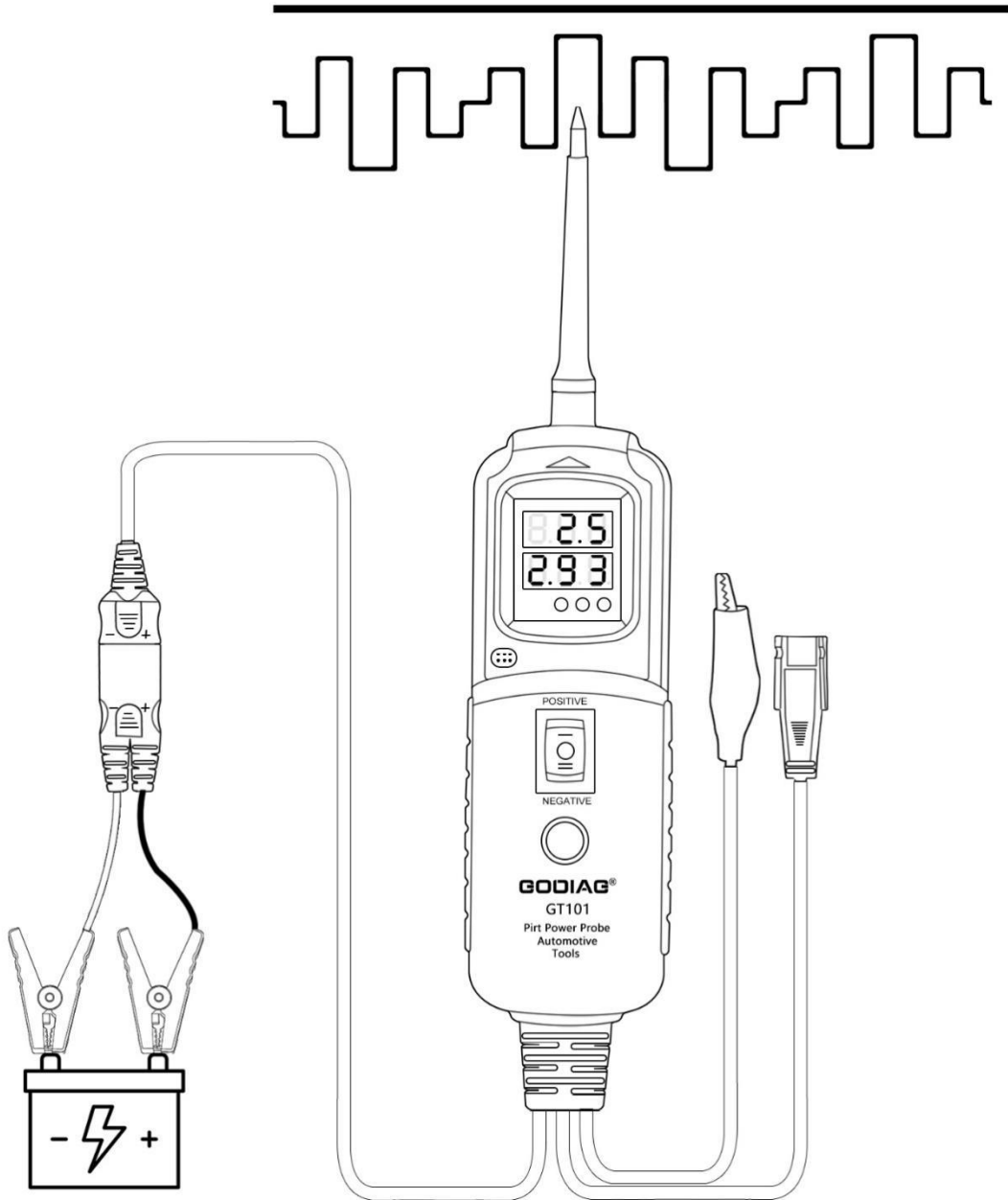

Note: The insulated wire needs to be pierced into and connected to the copper wire by the probe before it can be detected.

2.) Circuit Judgement-Judging circuit characteristics by voltage

a. The complete circuit judgement--GODIAG PIRT Power Probe detects from the starting point to the ending point of the same power line. If the electrical characteristics remain the same, it means that the circuit path is complete and normal.

b. The open circuit judgement --GODIAG PIRT Power Probe detects from the starting point

to the ending point of the same power line. If the electrical characteristics appear at the starting point but disappears at the end of the power supply, it means that the circuit path is open.

c. The short circuit judgement--GODIAG PIRT Power Probe detects from the starting point to the ending point of the same power line. If the electrical characteristics appear at the starting point but different electrical characteristics appear at the ending point of the power supply, it means that this power line is short with other lines.

3.) Individual Accessory Test

It can be used to test illumination lamp, turn signal light, door lock actuator, window regulator lift motor, car horn, switch, solenoid valve, relay, oil pump, fuel injector, ABS pump motor, engine control unit (ECU), etc.

Operating Steps :

1. Connect the black battery clip of GODIAG PIRT Power Probe to the negative electrode of the battery and the red battery clip to the positive electrode of the battery. If GODIAG PIRT Power Probe displays normally and lighting LED lights, it means that the power supply of the device is normal.
2. Connect the device's auxiliary ground wire clip to the negative pole of the component to be tested.
3. Connect the probe to the positive pole of the module. If the module has low resistance, the green LED light of the device should be on. The buzzer emits a low-frequency sound, and the voltmeter displays a voltage of 0.00V. (Indicates that the module is connected properly)
4. Press the ship-shaped function switch forward, the positive charge of the vehicle battery is input to the probe via the device, and the red LED light should be on. The buzzer makes a rapid sound, and the voltmeter displays the current positive voltage. The ammeter displays the current required by the module to work. If the module works normally, it means that the module is in normal status. (If it does not work properly, it means that the module is damaged.)

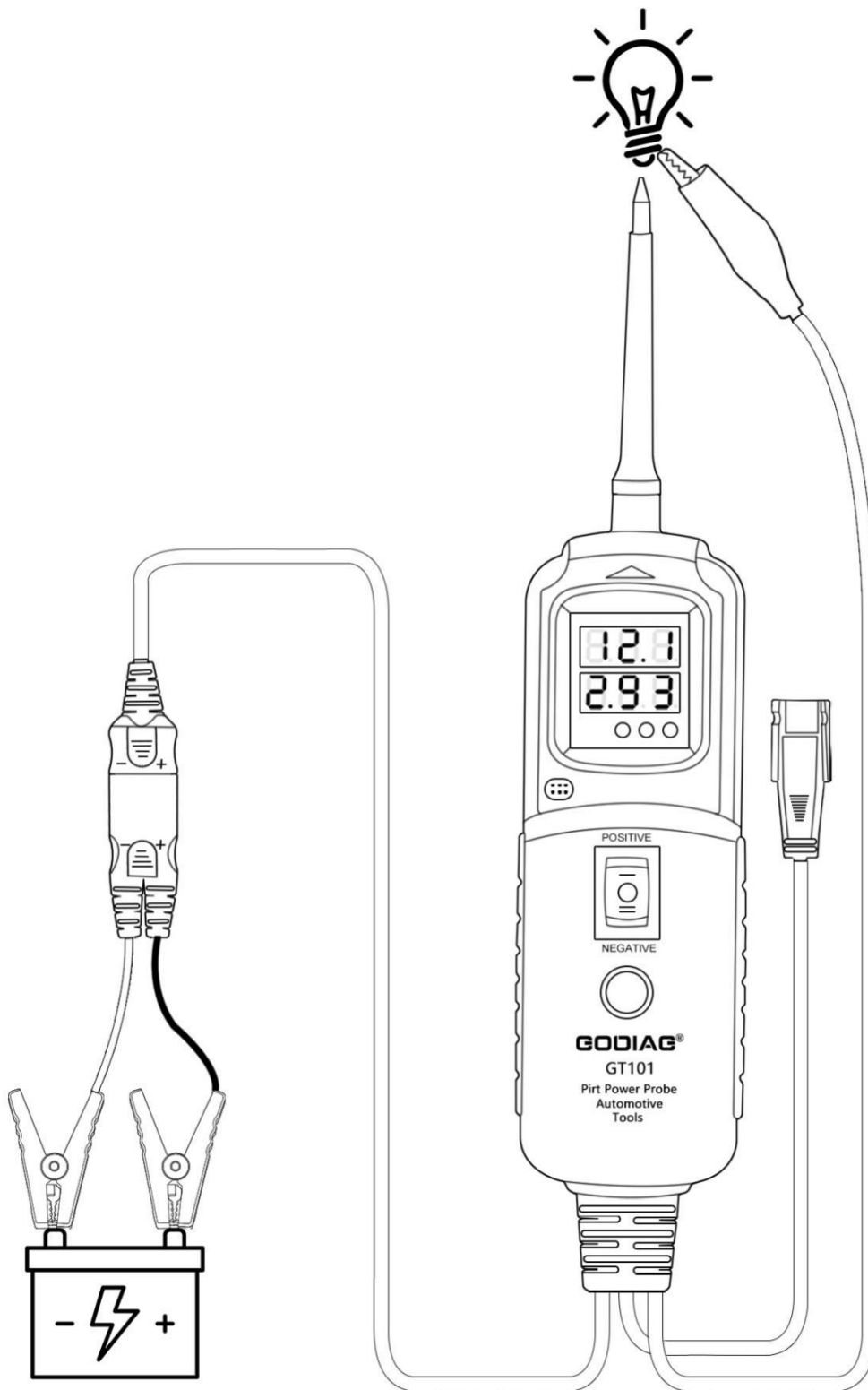

4.) Ammeter Display

1. The black battery clip of the GODIAG PIRT Power Probe is connected to the negative electrode of the battery, and its red battery clip is connected to the positive electrode of the

battery. If the GODIAG PIRT Power Probe displays normally and the illumination LED is on, it means that the power supply of this equipment is normal.

2. Connect the device's auxiliary negative pole clip to the negative pole of the component to be tested.
3. When the probe is connected to the current device under test, press the function button forward to input the positive charge to the device under test.
4. At this time, the red LED light of the device is on, the buzzer emits a rapid sound; and the voltmeter displays the voltage of the power supply. Ampere-meter displays the current of the vehicle module under test. (Engineers can judge whether the vehicle module meets the normal standards based on the data of the current.)

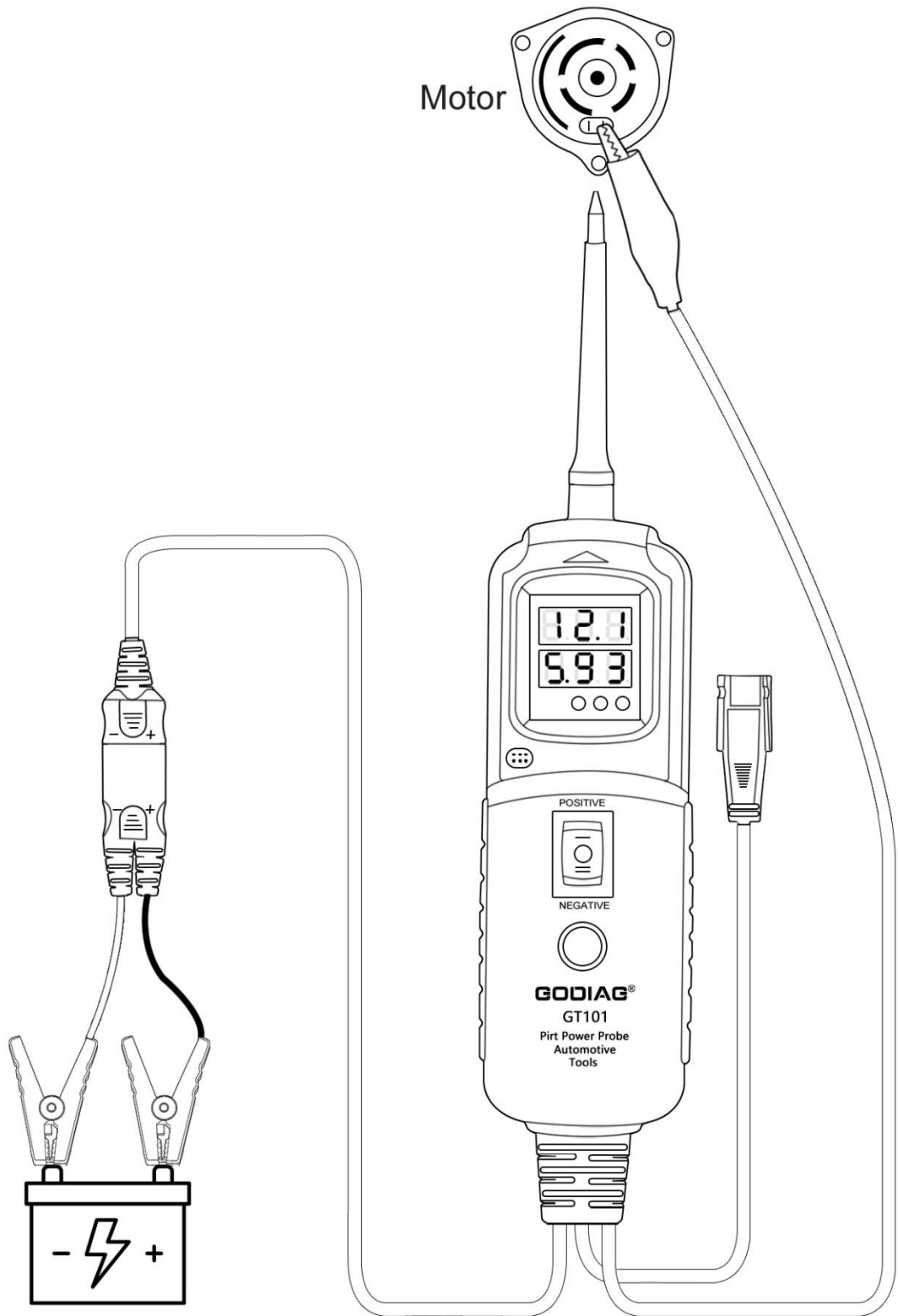

5.) Socket Module Components Test

If the maintenance technicians or engineers have already known the principle of control and the module components are connected to the vehicle normally. You can directly input

positive or negative electricity to the socket through the probe, and the maintenance technicians or engineers can judge the point of failure according to the testing result.

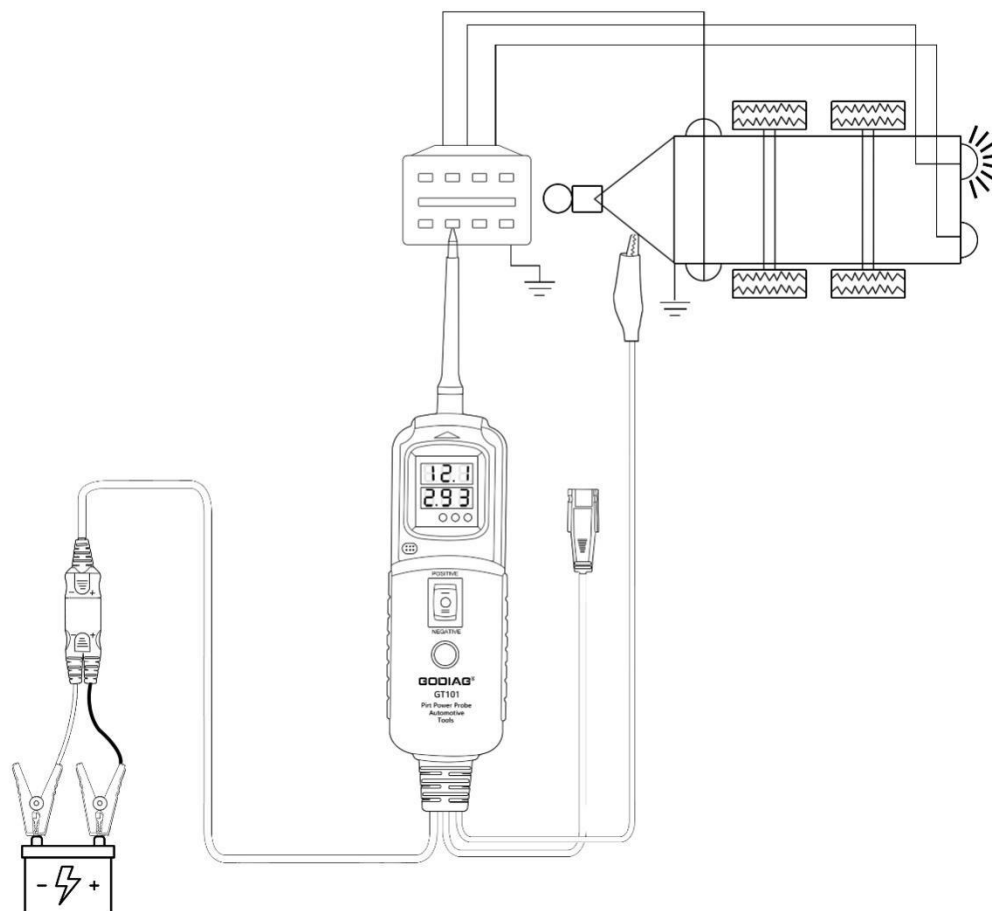

2.) Test of Modules Installed in the Vehicles

This product can test modules installed in the vehicles. Engineers can judge the performance of components based on their own experience and technology. Let the probe output positive or negative electricity to achieve the purpose of testing a single component.

Use this product to perform activation tests on the modules or components installed in the vehicle. Find the positive circuit and connect the probe to the positive electrode of the circuit. If the green LED lights, the buzzer emits a low-frequency sound, it means that the GND connection of the module or component is normal. Press the GODIAG PIRT Power Probe power output function switch forward, positive electricity will be output to the probe circuit. If the vehicle module or component can work normally, it means that there is a problem with the vehicle's positive power supply circuit for this module.

Note: If the pressing of the positive output causes a trip and open circuit, it means that the tool has been overloaded.

The following reasons may explain it: The probe is directly in contact with GND or the component you are testing is short-circuited.

If the positive output of the product is delivered to a high-current module or component, it will cause the product to trip. At this time, reconnect the device and it will function normally.

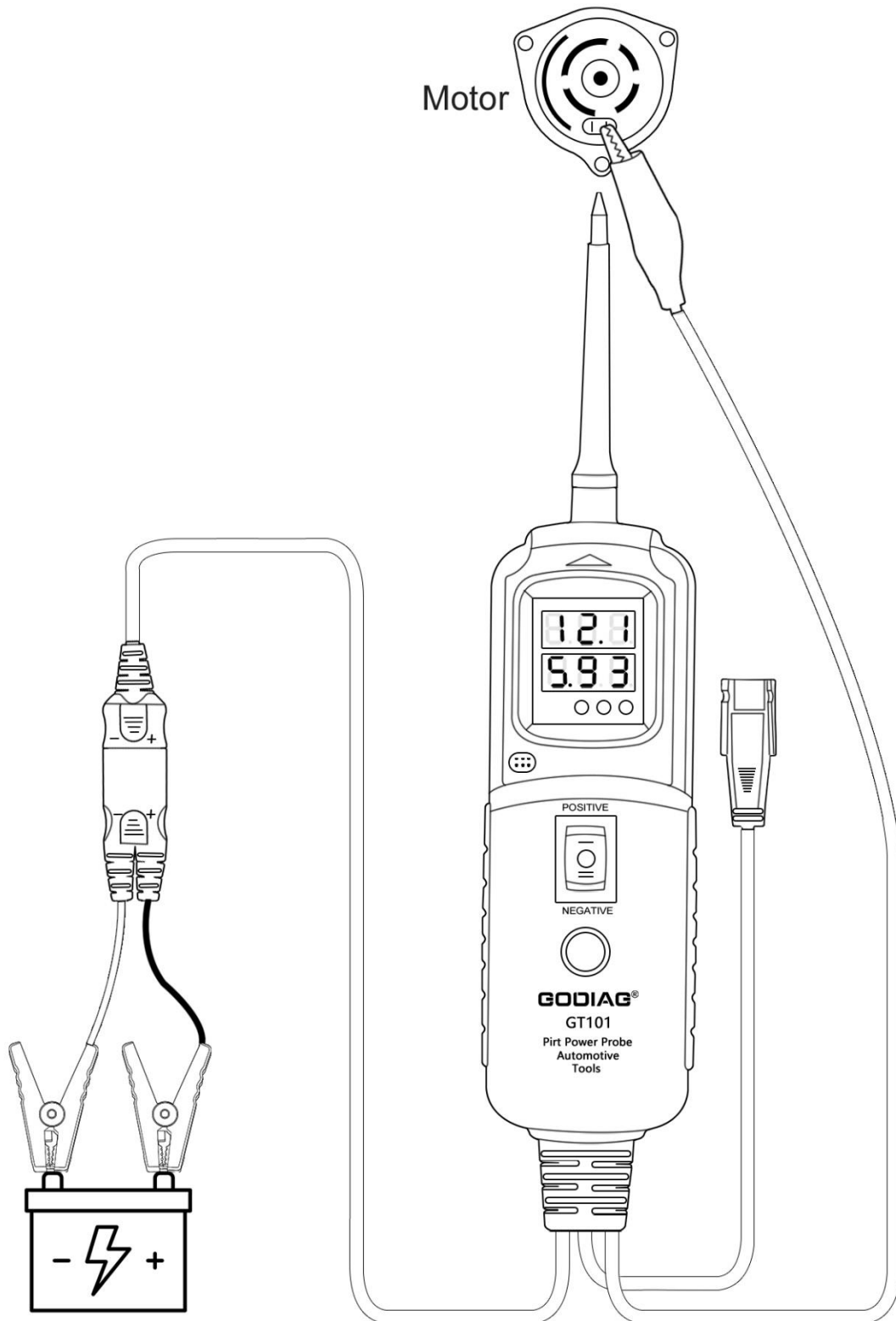

Negative circuit module and component circuit activation test. Find the GND connection of the vehicle module according to the circuit schematic diagram. After the probe touches GND, the red LED light should light. The buzzer makes a rapid sound, the voltmeter displays the current voltage, and the function switch is pressed backward to output the

negative circuit to the probe. If the vehicle module or component can work normally, it means that there is a problem with the GND wiring of the module.

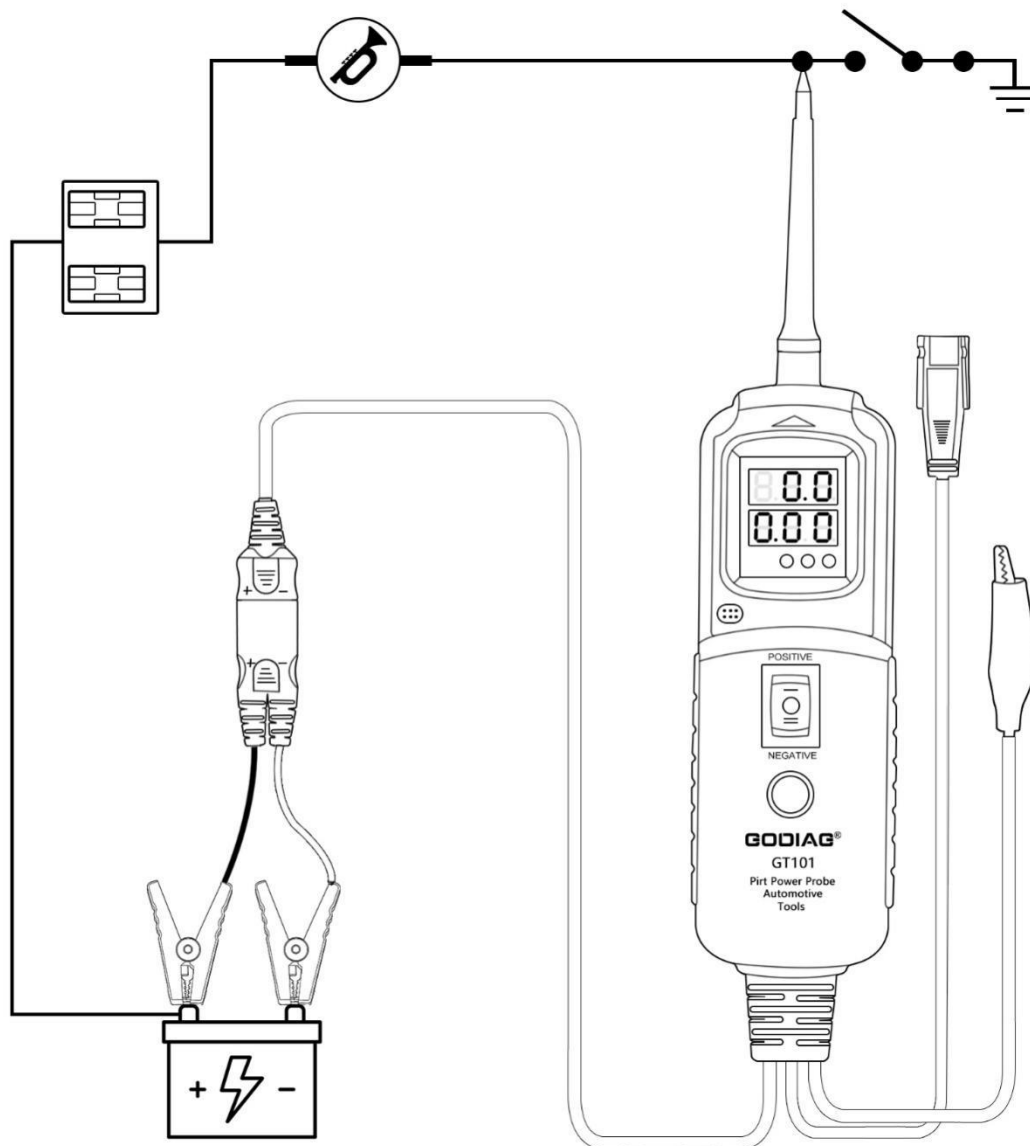

WARNING : Haphazardly applying voltage to certain circuits can cause damage to a vehicle's electronic components. Therefore, it is strongly advised to use the vehicle manufacturer's schematic and diagnosing procedure while testing.

7.) The Module Test Demonstration

Fuse test, battery voltage test, vehicle LAN circuit test, Hall sensor performance test, real electricity virtual electricity test, ignition pulse signal test, throttle voltage signal test, crankshaft sensing, camshaft sensing, speed signal.

8.) Fuel Injector Testing and Cleaning

Fuel Injector Testing :

1. Connect the black battery clip of the GODIAG PIRT Power Probe to the negative electrode of the battery the red battery clip to the positive electrode of the battery.
2. Connect the fuel injector test line to the fuel injector to be tested.
3. Press the fuel injector relay function button and the buzzer will beep once. The function output green light flashes.
4. The control signal is sent to the plug of the fuel injector to drive the fuel injector to open and close. The ammeter shows the working current of the fuel injector.

If the fuel injector is driven to open and close, the current shows a normal value, indicating that the fuel injector under test is normal.

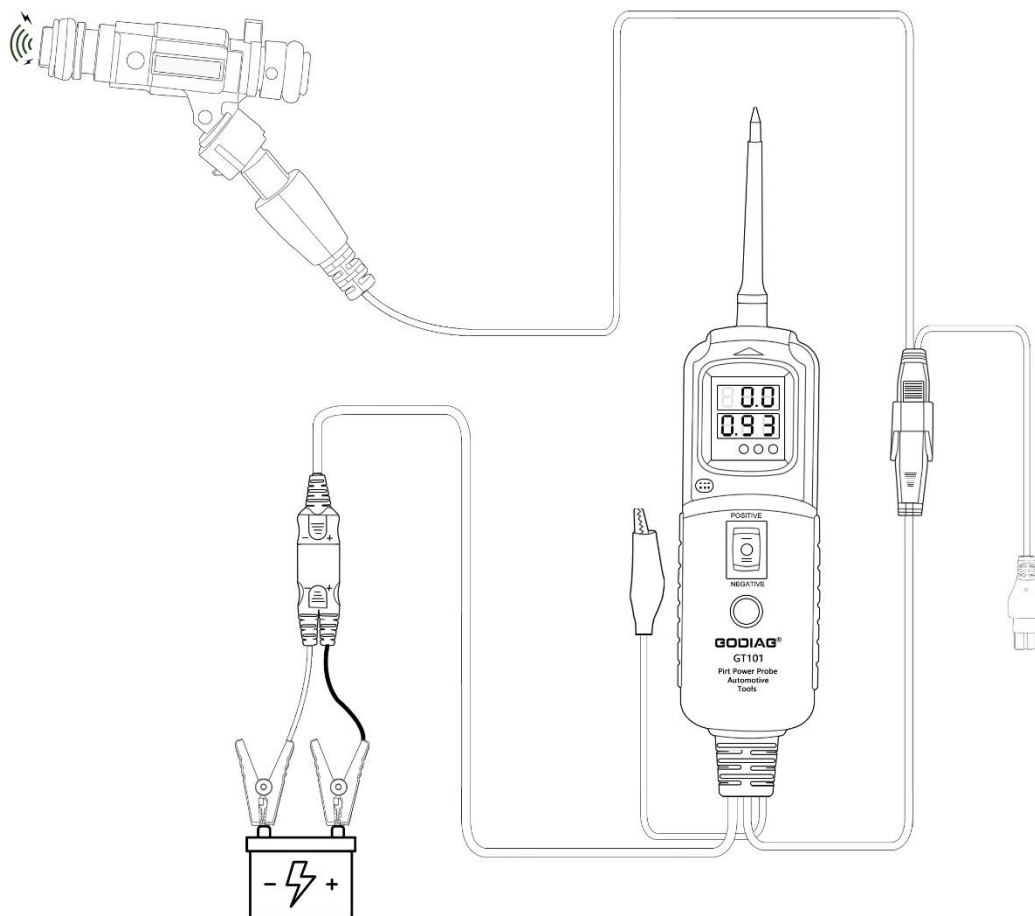

Manual Cleaning of Fuel Injectors :

1. Prepare a fuel injector cleaner pressurized can or a carburetor cleaner pressurized can (nozzle diameter of the pressurized cans : 4mm). Connect the fuel injector and manually clean the connector.
2. Connect the black battery clip of GODIAG PIRT Power Probe to negative electrode of the battery and the red battery clip to the positive electrode of the battery. If GODIAG PIRT Power Probe displays normally, and the illumination LED lights, it means that the power supply of the device is normal.
3. Connect the injector test line to the injector that needs to be cleaned.

4. Press the fuel injector relay function button and the buzzer will beep once. The function output green light flashes.
5. The control signal is sent to the fuel injector plug so as to drive the fuel injector to open and close. The ammeter shows the working current of the fuel injector.
6. Hold the manual cleaning tool tightly with your hand, and firmly fix the fuel injector with your fingers to prevent the pressure of the cleaner can from washing away the the fuel injector.
7. Clean the fuel injector under GODIAG PIRT Power Probe program.

(Note: Pay attention to the hazards of liquid to human body during manual cleaning, and take protective measures. Do not operate in dangerous places with open flames because the pressurized cans are extremely flammable. Choose an open place to facilitate the discharge of cleaning liquid.)

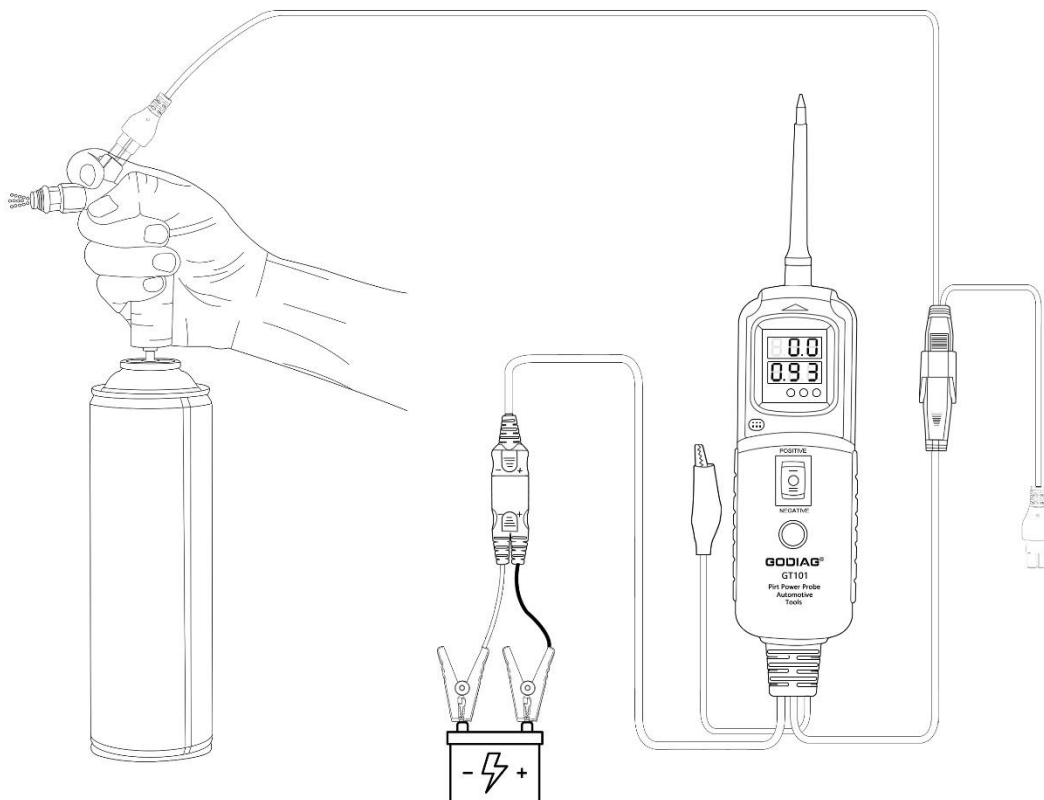

9.) Relay Test

Three Kinds of Relay Connection:

1) Conventional Relays

Relay port 86, Positive power supply (red), 85 power supply negative (black), 30 COM (yellow), 87 Normally Open (green), 87a Normally Closed (blue)

2) Special Relays

Relay port 1. Negative power supply (black), 2. Positive power supply (red), 3. COM (yellow), 4. Normally Closed (blue), 5. Normally Open (green)

3) Other Relays (port definition is not specific)

Users define the connection according to the port of the relay.

Relay Test Procedures

1. Prepare relay test leads and connection adapters.
2. According to the characteristics of the relay, customers can distinguish, the coil end of the relay, the common end, the normally open end and the normally closed end. Connect the relay.
3. Connect the black battery clip of GODIAG PIRT Power Probe to the negative electrode of the battery and the red battery clip to the positive electrode of the battery. If the GODIAG PIRT Power Probe displays normally, and the illumination LED lights it means that the power supply of the equipment is normal.
4. Press the function button of the fuel injector relay and the buzzer will beep once. Function output green light flashes .
5. The relay test signal is transmitted to the relay test line and the relay adapter to drive the relay to work. The ammeter shows the working current of the relay.
- 6.

Result Judgment:

A. For relays with normally open and normally closed functions, the red power light on the relay adapter flashes; for the normally open, green light flashes; for the normally closed, the blue light flashes. The current displays normal current value.

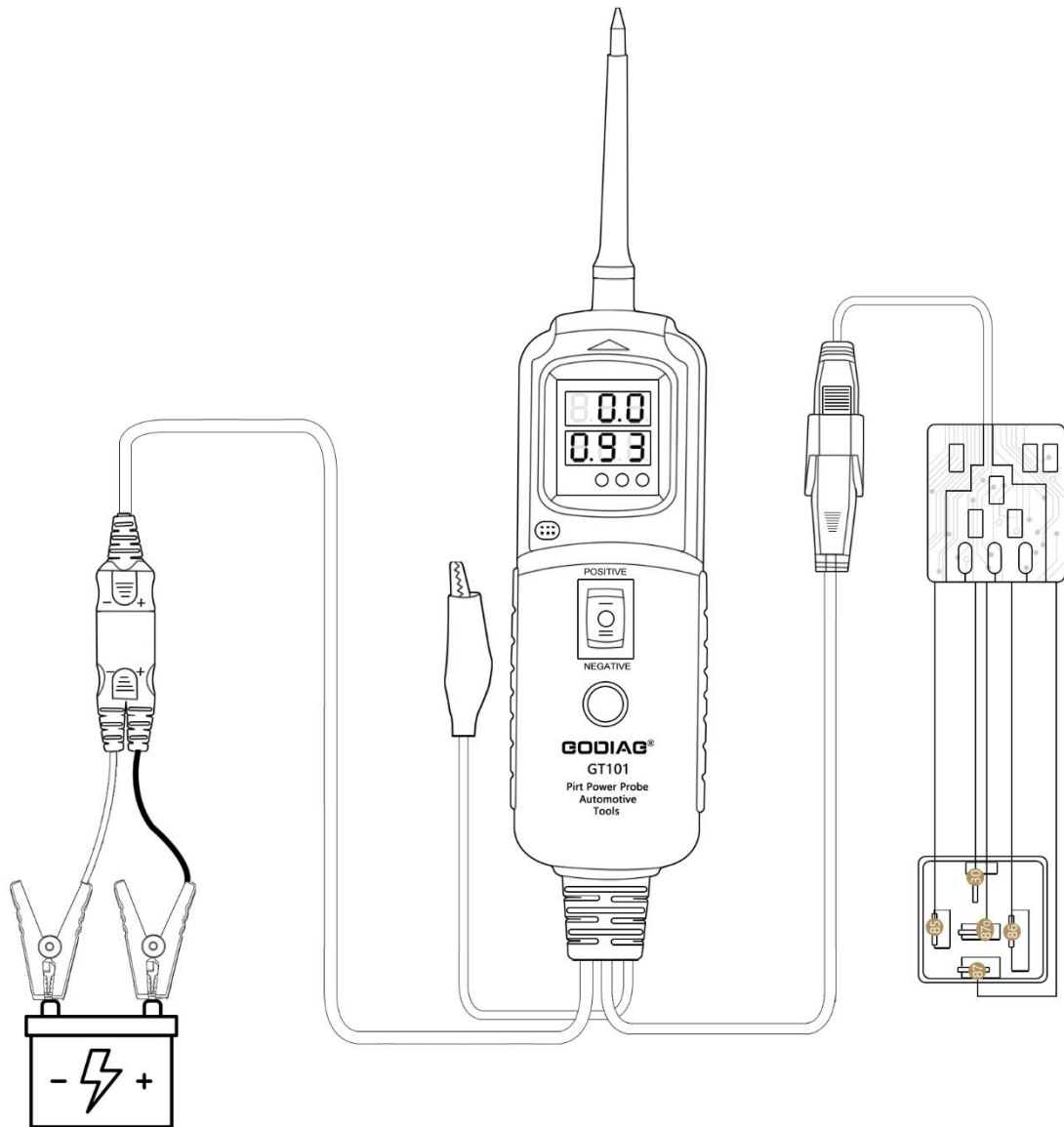

B. For relays with only normally open function, the red power light on the relay adapter flashes; for the normally open, the green light flashes; for the normally closed, the blue light goes out. The current shows the normal current value.

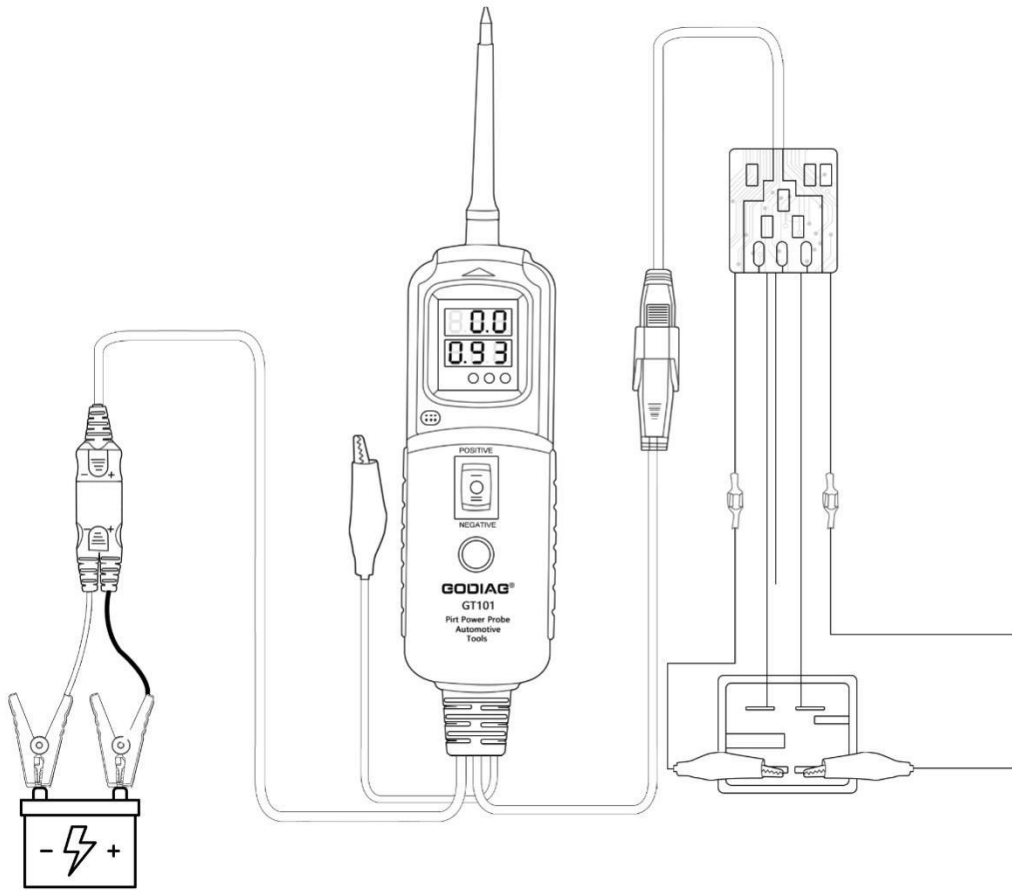

12. Product Size

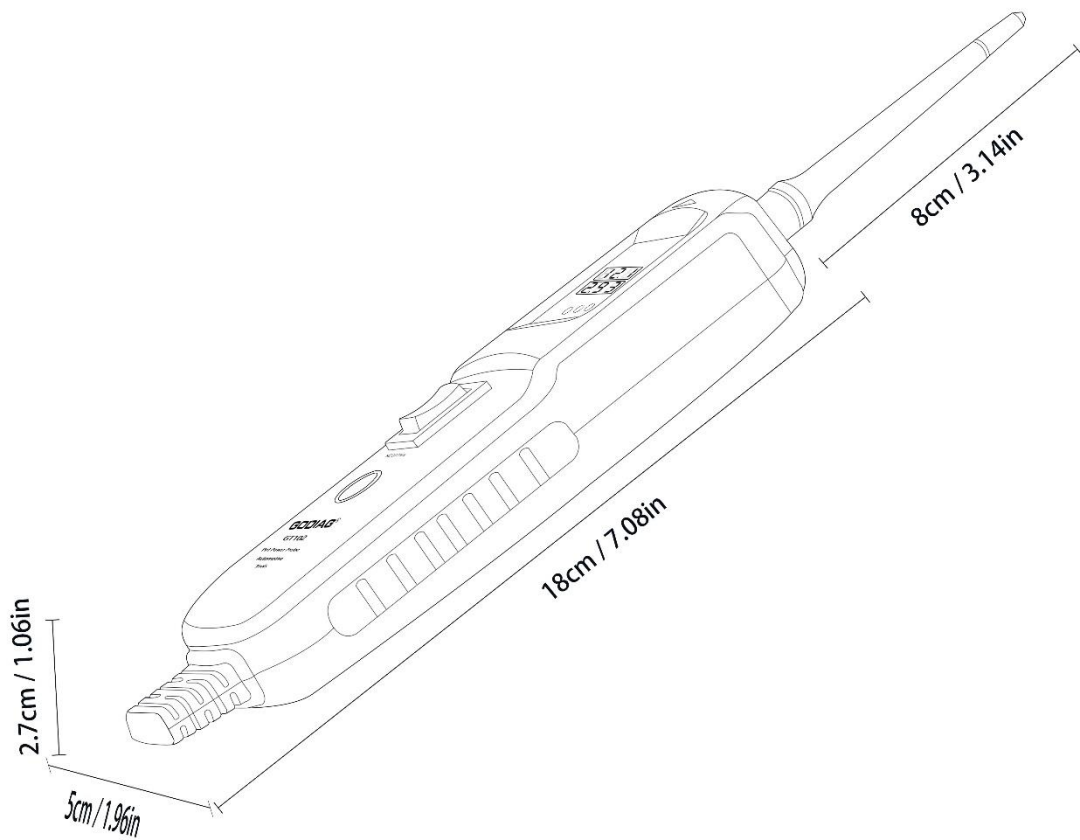

Package Includes:

Main Part of GODIAG GT101 PIRT Power Probe	1pc
Clip to Connect Battery	1pc
Probe	1pc
Probe Cap	1pc
Fuel Injector Test Lead	1pc
10mm Fuel Injector Cleaning Connector	1pc
12mm Fuel Injector Cleaning Connector	1pc
Simple Relay Test Adapter	1pc
Simple Relay Connection Leads	5pcs
Instruction	1pc

13. Warranty Service

This product provides one-year warranty service.

This warranty does not apply to damages caused by improper use, accident, flood, lightning, or if the product was altered or repaired by anyone other than the Manufacturer's Service Center.

If the device needs to be repaired, please fill in the service information below:

Contact name

Return address

Phone Number

Concise and Comprehensive Problem Description:

Proof of Purchase

Send the device to the local dealer.



Shenzhen Sinoy Technology Co.,Ltd

All Rights Reserved

www.godiag.com

+86 18813687743

Sales@godiag.com



Thanks for Reading!